DOLMAR



GB Gasoline Engine Pump

Instruction manual

F Motopompe

Manuel d'instructions

E Moto bomba

Manual de instrucciones

MP-352.4

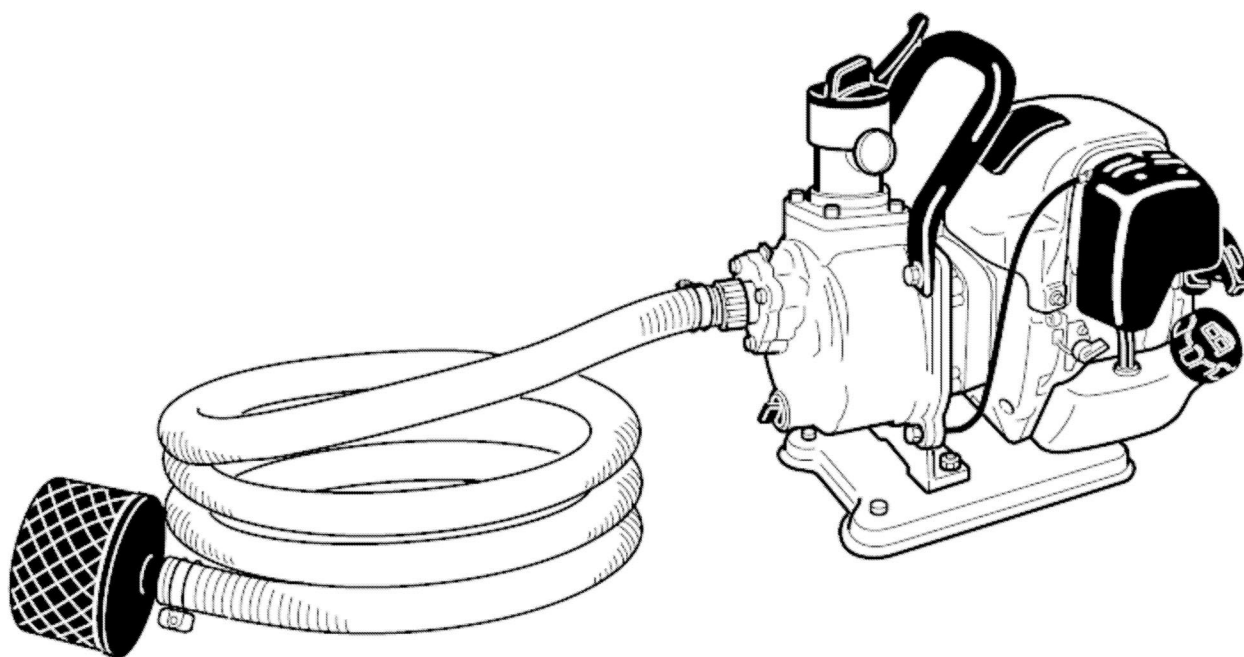

! WARNING

PLEASE READ AND UNDERSTAND

THIS MANUAL COMPLETELY BEFORE OPERATING THE MACHINE.

Particularly important information is distinguished in this manual by the following notations.

! ATTENTION

IL EST CONSEILLÉ DE LIRE CE MANUEL ATTENTIVEMENT ET INTÉGRALEMENT AVANT D'UTILISER LA MACHINE.

Dans ce manuel, les informations particulièrement importantes sont indiquées de la manière suivante.

! ADVERTENCIA

POR FAVOR LEA Y COMPRENDA ESTE MANUAL CON CUIDADO ANTES DE USAR LA MÁQUINA.

En este manual las informaciones muy importantes están remarcadas de la siguiente manera.

! WARNING

Failure to follow WARNING instructions could result in severe injury or death to the machine operator, a bystander, or a person inspecting or repairing the machine.

! ATTENTION

Le non-respect des instructions ATTENTION peut entraîner des blessures sérieuses voire même mortelles pour la personne utilisant la machine, un passant ou la personne vérifiant ou réparant la machine.

! ADVERTENCIA

La inobservancia de las instrucciones ADVERTENCIA puede ocasionar heridas graves o la muerte del operador o de la persona de inspección o reparación de la máquina.

CAUTION:

A CAUTION indicates special precautions that must be taken to avoid damage to the machine.

PRÉCAUTION:

PRÉCAUTION indique les précautions à prendre pour éviter d'endommager la machine

PRECAUCIÓN:

PRECAUCIÓN muestra la indicación de las precauciones que se deben tener para evitar daños a la máquina.

NOTE:

A NOTE provides key information to make procedures easier or clearer.

NOTA BENE:

NOTA BENE donne des informations nécessaires à une manipulation plus simple et plus claire de la machine.

NOTA:

Una NOTA provee la información necesaria para hacer el procedimiento fácil y claro.

Explanation of warning signs

Signification des étiquettes

Explicación de la etiqueta de ADVERTENCIA



Never use the engine indoors.
Ne jamais utiliser le moteur à l'intérieur.
No usar nunca el motor en el interior de un ambiente.



Don't touch the engine when it is hot.
Ne pas toucher les pièces chaudes du moteur.
No tocar, son las partes calientes del motor.



Before refueling, be sure to stop the engine.
S'assurer que le moteur est arrêté avant de faire le plein.
Antes de repostar combustible, asegurarse de apagar el motor.

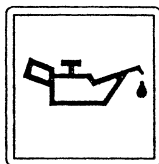

Check the oil level before starting.
Vérifier le niveau d'huile avant le démarrage.
Revisar el nivel de aceite antes de arrancar.

CONTENTS

TABLE DES MATIÈRES

ÍNDICE

NOMENCLATURE

TERMINOLOGIE

NOMENCLATURA 7

PRE-OPERATION CHECKS

VÉRIFICATION AVANT UTILISATION

INSPECCIONES ANTES DEL USO 6

OPERATION

MARCHE

FUNCIONAMIENTO 9

TROUBLE AND REMEDY

PROBLÈMES ET REMÈDES POUR LA PARTIE POMPE

AVERÍA Y REPARACIÓN 11

TROUBLESHOOTING PROCEDURES

PROBLÈMES ET REMÈDES POUR LA PARTIE MOTEUR

PROCEDIMIENTO PARA LOCALIZACIÓN DE AVERÍAS 13

SPECIFICATIONS

SPÉCIFICATIONS

ESPECIFICACIONES 15

SAFETY PRECAUTIONS

SÉCURITÉ

MEDIAS DE SEGURIPAD 16

NOMENCLATURE
TERMINOLOGIE
NOMENCLATURA

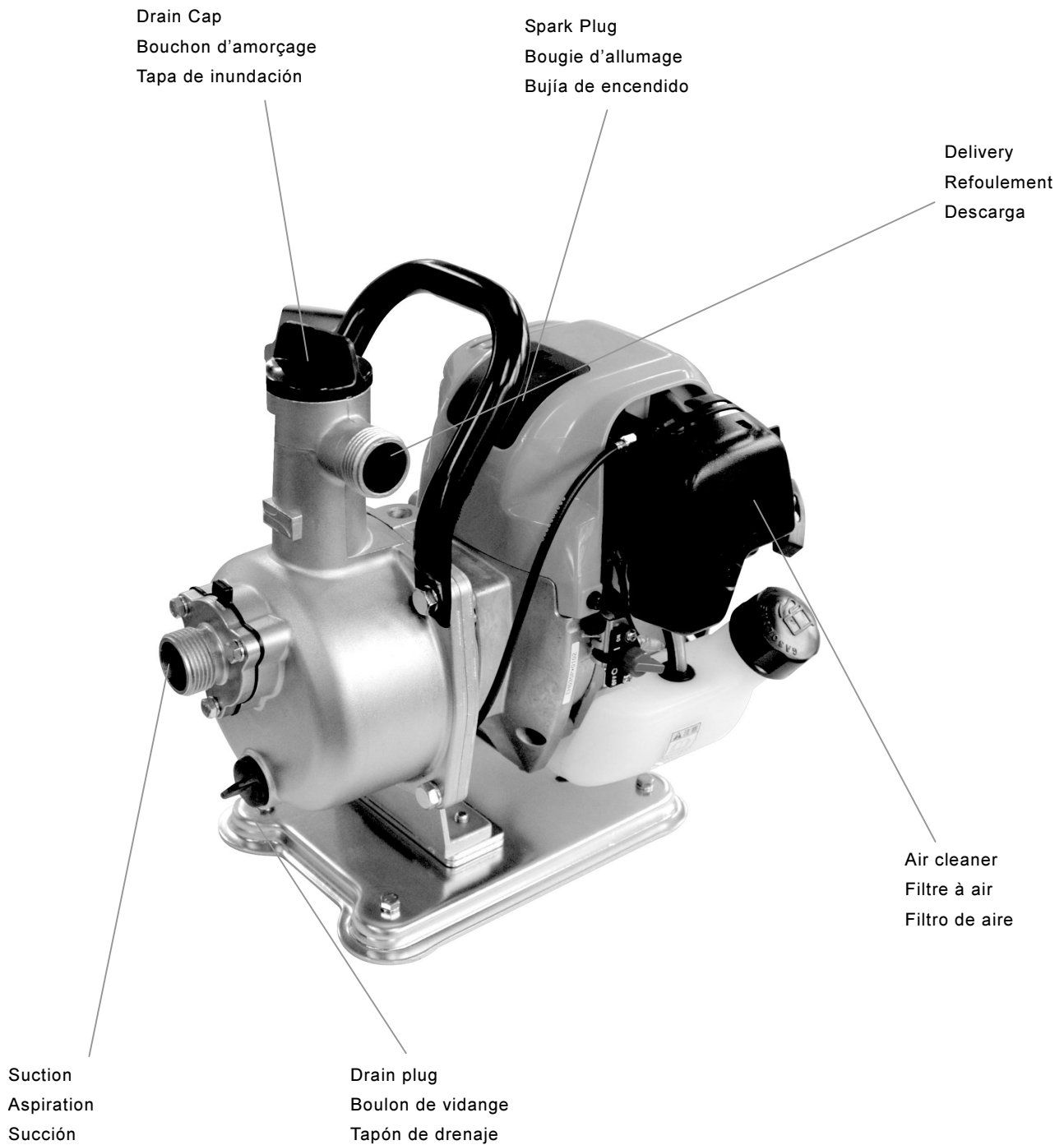

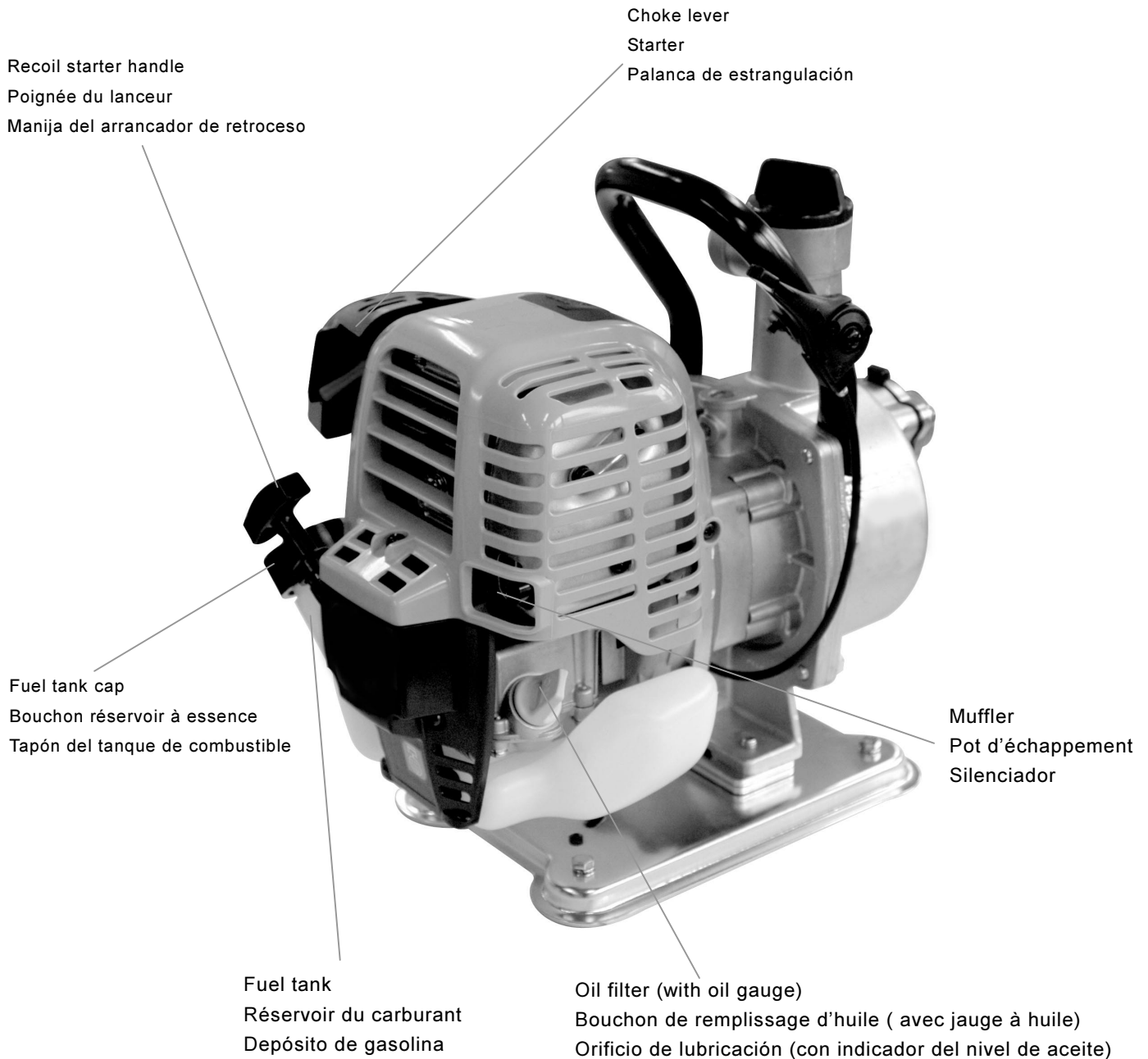

Standard accessories

Tool kit (Engine)
Instruction manual
Strainer (1 PC)
Pipe joint ass'y (2 PCS)
Hose band (3 PCS)

Accessoires standard

Jeux d'outils (Moteur)
Manuel d'instructions
Crépine (1 pc)
Raccord pour tuyau (2 jeux)
Collier pour tuyau (3 pcs)

Accesorios normales

Juego de herramientas (Motor)
Manual de instrucciones
Colador (1 pieza)
Ensamblaje de unión de tubo (2 piezas)
Abrazadera para manguera (3 piezas)

PRE-OPERATION CHECKS
VÉRIFICATION AVANT UTILISATION
INSPECCIONES ANTES DEL USO

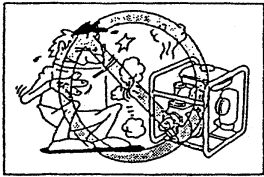

! **WARNING** Avoid touching the engine and muffler with any part of your body or clothing during inspection or repair, while they are still hot.

! **ATTENTION** Lors de la vérification ou réparation, faire attention qu'une partie du corps ou un vêtement ne vienne toucher le moteur ou le pot d'échappement si ces derniers sont encore chauds.

! **ADVERTENCIA** Evitar tocar el motor y silenciador mientras estén calientes con cualquier parte del cuerpo o ropa durante la inspección o reparación.

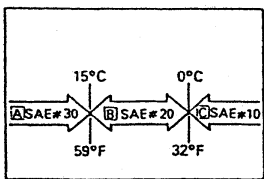

Engine oil Recommended oil: 4-stroke engine oil

Huile moteur Huile recommandée : huile pour moteur à 4 temps

Aceite para motor Aceite recomendado: Aceite para motor de 4-tiempos

NOTE: API service Classification SE or SF, if not available, SD.

NOTA BENE: Classification du service API SE ou SF, si non disponible SD.

NOTA: Clasificación de servicio API SE o SF, si no se encuentra a disposición, utilice SD.

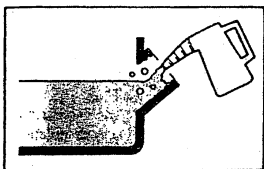

Engine oil quantity: 0.1 L

Quantité d'huile moteur: 0,1 L

Capacidad de aceite para motor: 0.1L

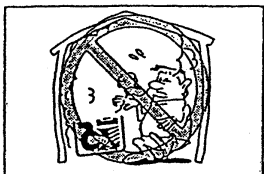

A NOTE FOR SAFE OPERATION

- Take special care of ventilation. Beware of CO poisoning.

A NOTA POUR LA SÉCURITÉ

- Veiller à une bonne aération. Attention aux gaz d'échappement.

A NOTA PARA UN FUNCIONAMIENTO SEGURO

- Tenga cuidado especial con la ventilación. Cuidado de no tener intoxicación por monóxido de carbono (CO).

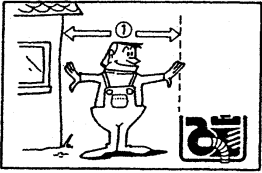

- B** • Keep inflammables away from the exhaust outlet. ① 1 m (3.94 in)
- B** • Eloigner tout produit inflammable de la sortie d'échappement. ① 1m (3,94 in)
- B** • B Mantenga los productos inflamables a distancia de la válvula del escape. ① 1m (3,94 in)

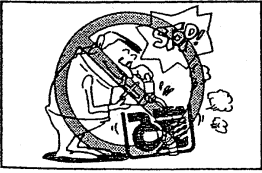

- C** • Before refueling, be sure to stop the engine.
 - Never refuel while smoking or in the vicinity of an open flame.
 - After refueling, make sure the tank cap is tightened securely.
- C** • Vérifier que le moteur soit bien arrêté avant de refaire le plein d'essence.
 - Ne jamais faire le plein d'essence en fumant ou à proximité d'une flamme.
 - Une fois le plein terminé, vérifier que le bouchon du réservoir à essence est bien resserré.
- C** • Antes de repostar combustible, no olvidar de parar el motor.
 - No repostar nunca combustible cuando esté fumando o cerca de una flama.
 - Después de repostar combustible, asegurarse de que el tapón del tanque esté bien cerrado.



A HOSE INSTALLATION

1. Install the hose joints on the pump.

CAUTION: When installing the joint to the pump, be sure the gasket is in place.

A INSTALLATION DES FLEXIBLES

1. Monter les raccords de flexible sur la pompe

PRÉCAUTION: Lors du montage de raccord à la pompe, vérifier que le joint d'étanchéité soit bien en place.

A INSTALACIÓN DE LA MANGA

1. Instalar la unión de manga en la bomba.

PRECAUCIÓN: Al instalar la unión en la bomba, asegurarse de que la junta esté en su lugar.



- B** 2. Connect the hoses on the joints with band.

3. Connect the strainer on the inlet hose end.

NOTE: Should air leak, water could not be drawn up.

- B** 2. Fixer les flexibles sur les raccords avec un collier.

3. Fixer, de même, la crépine à l'autre extrémité du flexible d'aspiration.

NOTA BENE: Si les fixations ne sont pas correctes, l'air entrera dans les flexibles et l'eau ne pourra pas être aspirée.

- B** 2. Juntar la manguera en la unión con un fleje.

3. Juntar el tensor a la toma de la manguera.

NOTA: En caso de fuga de aire, el agua no se puede succionar.

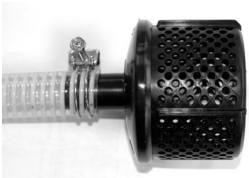

C CAUTION: Do not remove strainer or pump damage may occur by foreign material.

C PRECAUTION: Ne pas retirer la crépine car la pompe risquerait d'être endommagé par les corps étrangers alors aspirés.

C PRECAUCIÓN: No quitar el tensor, dado que materiales extraños pueden dañar la bomba.

Fuel

Recommended fuel: Regular Gasoline

Fuel tank capacity: 0.65L

! WARNING Fuel is highly flammable and poisonous. Check "NOTE FOR SAFE OPERATION" carefully before refueling.

Carburant

Carburant recommandé: essence normale

Capacité du réservoir: 0,65L

! ATTENTION: L'essence est un produit hautement inflammable et toxique. Toujours se conformer au "NOTA POUR LA SÉCURITÉ" avant de faire le plein du réservoir.

Combustible

Combustible recomendado: Gasolina Regular.

Capacidad del tanque de combustible 0.65L.

! ADVERTENCIA: La gasolina es una sustancia muy inflamable y tóxica. Revisar "NOTA PARA UN FUNCIONAMIENTO SEGURO" antes de repostar el combustible.



Water

1. Remove priming plug and add water until pump casing is filled up with water

CAUTION: Should the pump be started without water in the casing, mechanical seal could be damaged.

Eau

1. Retirer le bouchon d'amorçage remplir d'eau le corps de la pompe.

PRÉCAUTION: Ne jamais faire fonctionner la pompe si elle n'est pas pleine. Le joint mécanique risquerait d'être endommagé.

Agua

1. Quitar el tapón de cebador y añadir agua hasta que caja de la bomba esté completamente llena.

PRECAUCIÓN: Si la bomba se pone en marcha sin agua en la caja, puede dañarse el sello mecánico.

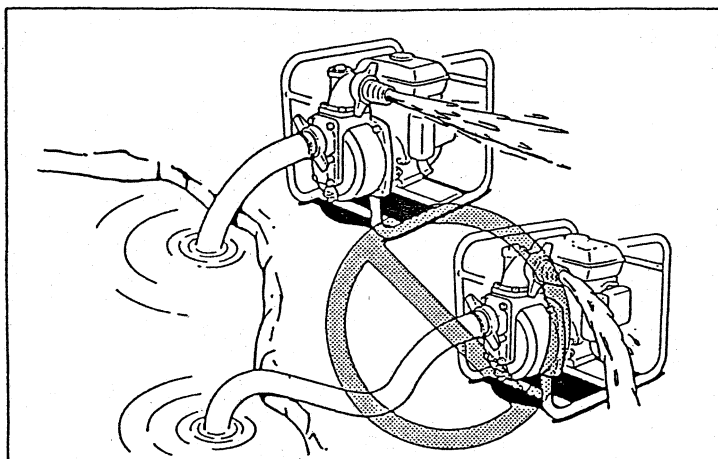

NOTE:

- Be sure the pump is placed on the firm place and as near to available water source as possible.
- The higher the suction head is the more time will be required for priming with a less discharge.

NOTA BENE:

- S'assurer que la pompe est installée sur un sol ferme et aussi près que possible d'une source d'eau.
- Plus la tête d'aspiration est élevée et plus le temps d'amorçage sera long et le débit sera faible.

NOTA:

- Asegurarse de que la bomba esté puesta en un lugar firme y lo más cerca posible de una fuente de agua.
- Cuanto más alta esté la carga de aspiración, más tiempo necesitará para la succión con una descarga menor.

OPERATION

CAUTION: This water pump has been shipped without engine oil. Unless you fill with oil, water pump damage will occur.

UTILISATION

PRÉCAUTION: Cette pompe à l'eau est expédiée sans huile moteur. Donc ne pas oublier de mettre de l'huile dans le moteur, faute de quoi la pompe serait endommagée.

FUNCIONAMIENTO

PRECAUCIÓN: Esta bomba de agua se envió sin incluir aceite para motor. A menos que Ud. La llene de aceite, puede causar daños en la bomba de agua.

Beware of water-hammering

Do not allow the wheel of a vehicle to run over the delivery hose. Do not close the delivery valve abruptly, because a water-hammer will occur which may result in heavy damage to the pump.

Attention au coup de bélier

Ne pas laisser le véhicule stationner sur le tuyau de refoulement ou ne pas fermer brusquement la vanne de refoulement, ce qui engendrerait un coup de bélier pouvant endommager grandement la pompe.

Tener cuidado con el ariete hidráulico

No deje que las ruedas de un vehículo pisen la manguera de descarga, o no cierre la válvula de descarga de una manera brusca. Si no, ocurrirá un ariete hidráulico que puede ocasionar daños graves a la bomba.

Do not put your hands or foreign objects in the release or valves when the pump is in use.

Ne pas laisser de corps étrangers du côté aspiration et refoulement pendant le fonctionnement de la pompe

No meter la mano o cuerpos extraños en la salida de descarga o la toma de aspiración durante el funcionamiento.

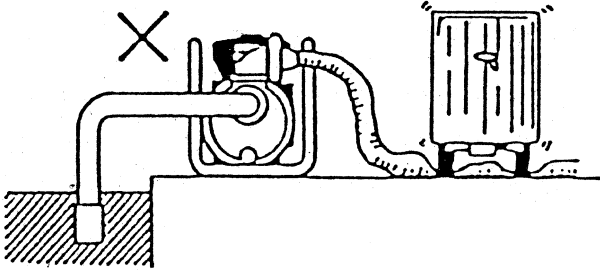

CAUTION: Running over the delivery hose.

PRÉCAUTION: Écrasement du tuyau de refoulement

PRECAUCIÓN: Cuidado con pisar la manguera de descarga.

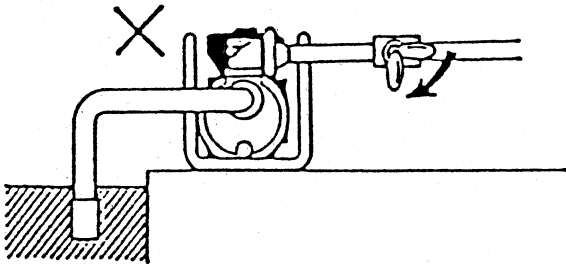

CAUTION: Abrupt closing of delivery valve.

PRÉCAUTION: Fermeture brusque de la vanne de refoulement

PRECAUCIÓN: Cuidado con cerrar la válvula de descarga en forma brusca.

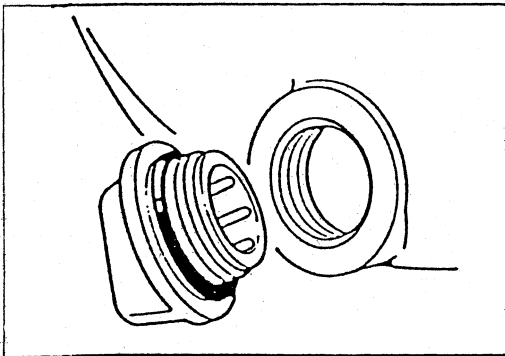

Drain of water after use.

Water inside casing freezes at below 0°C (32°F) in winter and there by pump may possibly break. After use, drain water from drain port at bottom to store.

Vidange de l'eau après utilisation

En hiver, l'eau restant dans la pompe gèle à 0°C (32 °F) et peut provoquer une cassure du corps de la pompe. Il est donc nécessaire de purger la pompe après son utilisation et avant son stockage.

Drenaje de agua después del uso

El agua dentro de la caja se congela a 0 °C (32°F) en invierno y como consecuencia de ello la bomba puede estropearse. Después de usarla, drene el agua por el orificio de drenaje antes de almacenarla.

TROUBLE AND REMEDY

- Pump does not revolve. — Engine does not start. (Refer to instruction manual of engine)
— Sticking of impeller (Disassemble & clean)
- Pumping volume is small. — Entrance of air at suction side (Check piping at suction side)
— Drop of engine output (Repair)
— Breakage of mechanical seal (Replace mechanical seal)
— High suction lift (Lower)
— Thin or long or kink of hose (Thicken or shorten or straighten)
— Leak of water from water passage (Stop leak)
— Clogging of foreign substance in impeller (Disassemble & clean)
— Wear of impeller (Replace impeller)
- Pump does not self-prime. — Suction of air at suction side (Check piping at suction side)
— Insufficient priming water inside pump casing (Prime fully)
— Imperfect tightening of drain cock (Tighten the 2 plugs completely)
— Imperfect revolution of engine (Repair engine)
— Entrance of air from mechanical seal (Replace mechanical seal)

PROBLEMES ET REMÈDES POUR LA PARTIE POMPE

- La pompe ne tourne pas — Le moteur ne démarre pas (Se référer au Manuel d'instructions du moteur)
— Encrassage du rotor (Démonter et nettoyer)
- Le volume pompe est faible — Entrée d'air du côté aspiration (Vérifier la conduite du côté aspiration)
— Baisse de puissance du moteur (Réparer)
— Rupturé du joint mécanique (Remplacer ledit joint)
— Côté aspiration surélevé (Le baisser)
— Tuyau fin ou long ou faux-pli (Épaissir, raccourcir ou retendre)
— Fuite d'eau dans les conduites (Arrêter la fuite)
— Encrassage du rotor (Démonter et nettoyer)
— Usure du rotor (Remplacer le rotor)
- Défaut de l'auto-amorçage — Entrée d'air du côté aspiration (Vérifier la conduite du côté aspiration)
— Eau d'amorçage insuffisante dans le corps de la pompe
(Remplir correctement)
— Mauvais serrage du boulon de vidange (Bien resserrer les 2 boulons)
— Mauvaise rotation du moteur (Réparer le moteur)
— Entrée d'air à partir du joint mécanique (Remplacer ledit joint)

AVERÍA Y REPARACIÓN

La bomba no gira.

- El motor no funciona. (Referirse al manual de instrucciones del motor)
- Se pega el impulsor. (Desmontar y limpiar)

Capacidad de bombeo es pequeña

- Entrada del aire en el lado de succión (Comprobar la tubería de la succión)
- Caída del rendimiento de motor (Reparar)
- Rotura del sello mecánico (Reemplazar el sello mecánico)
- Levantamiento prolongado de la altura de aspiración (Bajar)
- La manguera es delgada, larga o retorcida (Engrosar, cortar o enderezar)
- Fuga de agua desde el paso de agua (Eliminar la fuga)
- Atasco de sustancias extrañas en el impulsor (Desmontar y limpiar)
- Desgaste del impulsor (Reemplazar el impulsor)

La bomba no se autoceba.

- Succión de aire en el lado de succión. (Comprobar la tubería en la succión)
- Insuficiente agua de cebadura dentro de la caja de bomba (Cebador por completo)
- Cierre insuficiente del tapón de drenaje (Cerrar bien los dos tapones)
- Revolución de motor imperfecta (Reparar el motor)
- Entrada del aire desde el sello mecánico (Reemplazar el sello mecánico)

TROUBLESHOOTING PROCEDURES

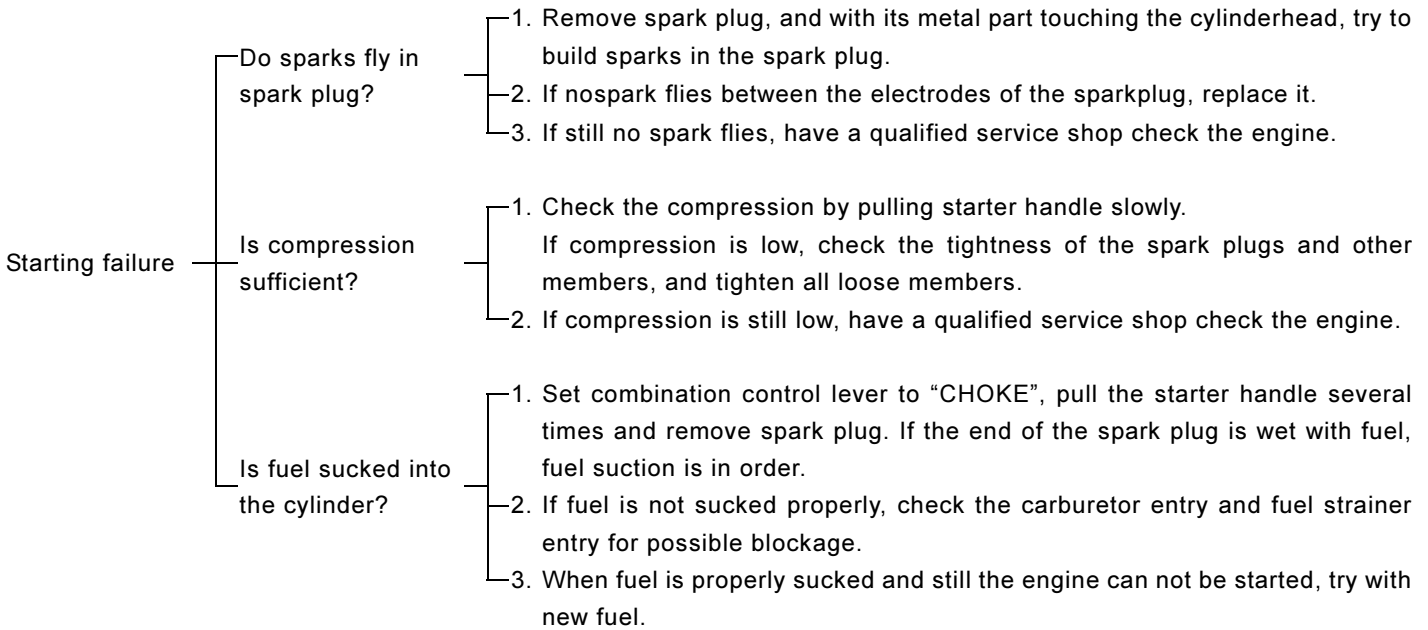

PROBLEMES ET REMEDES POUR LA PARTIE MOTEUR

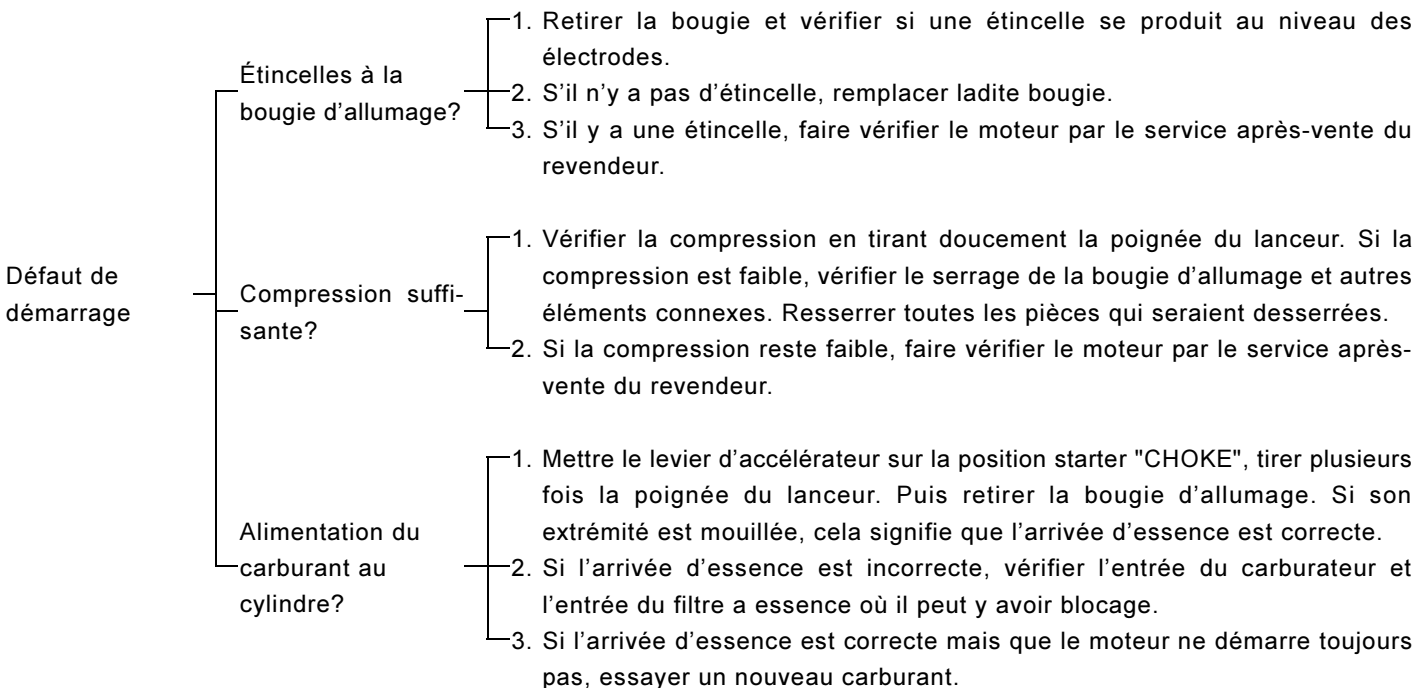

PROCEDIMIENTO PARA LOCALIZACIÓN DE AVERÍAS

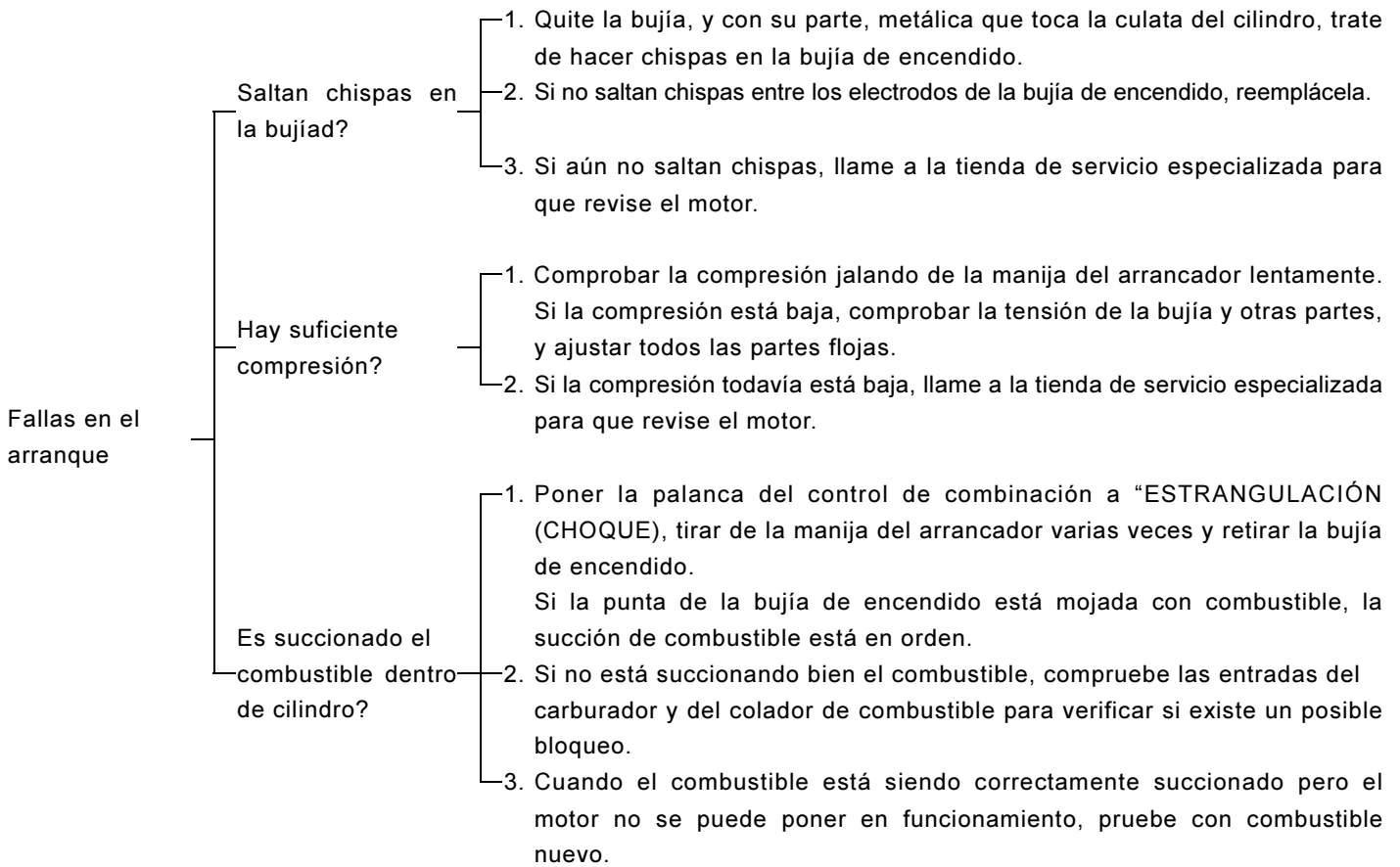

SPECIFICATIONS

	Model	MP-352.4
	Weight	7.5kg
Pump	Type	Self-priming CENTRIFUGAL PUMP
	Diameters (suction-discharge)	1 × 1in
	Total head	45m 148Ft
	Maximum delivery volume	130ℓ/min
	Maximum suction lift	26Ft(8m)
	Axle seal	Mechanical seal
	Engine	Type
Model		EH035P
Displacement cylinder		33.5cm ³
Fuel combustible		Automobile gasoline
Fuel tank capacity		0.65ℓ
Starting system		Recoil starter

The specifications are subject to change without notice for the purpose of product improvement.

SPECIFICATIONS

	Modèle	MP-352.4
	Poids	7.5kg
POMPE	Type	Pompe centrifuge à auto-amorçage
	Diamètres (aspiration-refoulement)	1 × 1in
	Chute totale	45m 148Ft
	Débit maximum	130ℓ/min
	Hauteur maximum d'aspiration	26Ft(8m)
	Joint d'axe	Joint Mécanique
	MOTEUR	Type
Modèle		EH035P
Cylindrée		33.5cm ³
Carburant		Essence ordinaire
Capacité du réservoir a essence		0.65ℓ
Système de démarrage		Lanceur à retour

En vue d'amélioration du produit, ces spécifications peuvent être modifiées sans préavis.

SPECIFICATIONS

	Modelo	MP-352.4
	Peso	7.5kg
BOMBA	Tipo	BOMBA CENTRIFUGA autocebable
	Diámetros (succión-descarga)	1 × 1in
	Altura de elevación total	45m 148Ft
	Volumen máximo de descarga	130ℓ/min
	Altura máxima de aspiración	26Ft(8m)
	Sello del eje	Sello mecánico
	MOTOR	Tipo
Modelo		EH035P
Desplazamiento del cilindro		33.5cm ³
Combustible		Gasolina para automóvil
Capacidad del depósito de combustible		0.65ℓ
Sistema de arranque		Arrancador de retroceso

Con el objeto una mejora del producto, las especificaciones están sujetas a cambios sin previo aviso.

The specifications are subject to change without notice for the purpose of product improvement.

En vue d'amélioration du produit, ces spécifications peuvent être modifiées sans préavis.

Con el objeto de una mejora del producto, las especificaciones están sujetas a cambios sin previo aviso.

SAFETY PRECAUTIONS

Please make sure you review each precaution carefully.

EXHAUST PRECAUTIONS

- Never inhale exhaust gasses.
They contain carbon monoxide, a colorless, odorless and extremely dangerous gas which can cause unconsciousness or death.
- Never operate the engine indoors or in a poorly ventilated area, such as tunnel, cave, etc.
- Exercise extreme care when operating the engine near people or animals.
- Keep the exhaust pipe free of foreign objects.

REFUELING PRECAUTIONS

- Be sure to stop the engine prior to refueling.
- Do not overfill the fuel tank.
- If fuel is spilt, wipe it away carefully and wait until the fuel has dried before starting the engine.
- After refueling, make sure that the fuel cap is secured to prevent spillage.

FIRE PREVENTION

- Do not operate while smoking or near an open flame.
- Do not use around dry brush, twigs, cloth rags, or other flammable materials.
- Keep the engine at least 3 feet (1 meter) away from buildings or other structures.
- Keep the engine away from flammables and other hazardous materials (trash, rags, lubricants, explosives).

SECURITE

Veillez suivre ces conseils pour une utilisation correcte et sûre de votre moteur.

ÉCHAPPEMENT

- Ne jamais respirer les gaz d'échappement. Ils contiennent du monoxyde de carbone, un gaz inodore, incolore et très dangereux, qui peut causer de graves accidents pour l'homme.
- Ne jamais utiliser le moteur dans un endroit comme ni un endroit insuffisamment ventilé tel que cave, tunnel etc.
- Être très prudent lors de l'utilisation du moteur près des enfants ou des animaux ou de quelques êtres vivants.
- Éviter le pot d'échappement.

PLEIN DE CARBURANT

- Arrêter le moteur avant de faire le plein.
- Ne pas faire déborder le carburant lors du plein.
- Essayer soigneusement toute trace de carburant sur le moteur et attendre que tout soit évaporé avant le démarrage.
- Après avoir fait le plein, vérifier que le bouchon du réservoir est bien en place pour éviter toute fuite.

PRÉVENTION DES INCENDIES

- Ne pas approcher du moteur avec une cigarette ou toute autre flamme.
- Ne pas utiliser le moteur près d'un stockage de matières inflammables.
- Utiliser le moteur à un mètre de tout obstacle, mur, meuble, porte,.....

MEDIDAS DE SEGURIDAD

Por favor, asegúrese de revisar detenidamente cada uno de estos apartados.

PRECAUCIONES CON LOS GASES DEL ESCAPE

- No inhale gases del escape.
- Contienen monóxido de carbono, un gas incoloro e inodoro. Sumamente peligroso que puede causar pérdida del conocimiento e incluso la muerte.
- No haga funcionar nunca el motor en recintos cerrados o en sitios con ventilaciones, etc.
- Tenga sumo cuidado cuando trabaje con el motor cerca de personas o animales.
- Mantenga el tubo de escape libre de cuerpos.

PRECAUCIONES DE LLENADO

- Asegúrese de parar el motor antes del llenado.
- No llene a rebosar el depósito de combustible.
- Si el combustible se derrama, límpialo con cuidado y espere hasta secado completamente antes de encender el motor.
- Cuando cambie el aceite, asegúrese de que el tapón del combustible está bien cerrado para prevenir cualquier derrame.

PREVENCIÓN DE INCENDIO

- No tenga el motor en funcionamiento mientras fuma, o cerca de una llama.
- No opere el motor cerca de arbustos secos, palos, hilachas u otros materiales inflamables.
- Mantenga el motor a una distancia mínima de un metro de edificios u otras instalaciones.
- Mantenga el motor lejos de materiales inflamables y de alto riesgo (basura, hilachas, lubricantes, explosivos).

EMISSION COMPLIANCE PERIOD

For handheld engine : The Emissions

Compliance Period referred to on the Emissions

Compliance label indicates the number of operating hours for which the engine has been shown to meet Federal emission requirements.

Category C=50 hours, B=125 hours, and A=300 hours.

AIR INDEX

An Air Index Information hang tag was supplied to this engine in accordance with the emission regulations of the California Air Resources Board.

The bar graph on the hang tag shows the emissions performance of this engine. The bar graph can be used to compare the emissions performance with other available engine. The lower the Air Index, the less pollution.

The following durability description is to provide you with information relating to the emission durability period of the engine.

<u>Descriptive Term</u>		<u>Applicable to Emissions Durability Period</u>
Moderate	-	50hours (0-65 cc)
Intermediate	-	125hours (0-65cc)
Extended	-	300hours (0-65cc)

Notice : The Air Index Information hang tag must remain on the engine or on the equipment until it is sold to the ultimate purchaser. Remove the hang tag before operating the engine.

CALIFORNIA EMISSIONS CONTROL WARRANTY STATEMENT

YOUR WARRANTY RIGHTS AND OBLIGATIONS

The California Air Resources Board and **DOLMAR GmbH North American Division. (Dolmar)** are pleased to explain the emissions control system's warranty on your 2007 and later small off-road engine. In California, new equipment that use small off-engines must be designed, built, and equipped to meet the State's stringent anti-smog standards. **Dolmar** must warrant the emissions control system on your small off-road engine for the period listed below provided there has been no abuse, neglect or improper maintenance of your equipment.

Your emissions control system may include parts such as: carburetors or fuel injection system, ignition system, catalytic converters, fuel tanks, valves, filters, clamps, connectors, and other associated components. Also, included may be hoses, belts, connectors, sensors, and other emission-related assemblies.

Where a warrantable condition exists, **Dolmar** will repair your small off-road engine at no cost to you including diagnosis, parts and labor.

MANUFACTURER'S WARRANTY COVERAGE:

This emissions control system is warranted for two years. If any emissions-related part on your equipment is defective, the part will be repaired or replaced by **Dolmar**.

OWNER'S WARRANTY RESPONSIBILITIES:

- As the small off-road engine owner, you are responsible for performance of the required maintenance listed in your owner's manual. **Dolmar** recommends that you retain all receipts covering maintenance on your small off-road engine, but **Dolmar** cannot deny warranty solely for the lack of receipts or your failure to ensure the performance of all scheduled maintenance.
- As the small off-road engine owner, you should however be aware that **Dolmar** may deny you warranty coverage if your small off-road engine or a part has failed due to abuse, neglect, or improper maintenance or unapproved modifications.
- You are responsible for presenting your small off-road engine to a **Dolmar Service Center** as soon as the problem exists. The warranty repairs should be completed in a reasonable amount of time, not to exceed 30 days. If you have a question regarding your warranty coverage, you should contact **Dolmar Warranty Service Department at 1-888-OPE-PART for the information.**

DEFECTS WARRANTY REQUIREMENTS:

- (a) The warranty period begins on the date the engine or equipment is delivered to an ultimate purchaser.
- (b) General Emissions Warranty Coverage. **Dolmar** must warrant to the ultimate purchaser and each subsequent owner that the engine or equipment is:
 - (1) Designed, built, and equipped so as to conform with all applicable regulations adopted by the Air Resources Board; and
 - (2) Free from defects in materials and workmanship that causes the failure of a warranted part for a period of two years.
- (c) The warranty on emissions-related parts will be interpreted as follows:
 - (1) Any warranted part that is not scheduled for replacement as required maintenance in the written instructions required by subsection (d) must be warranted for the warranty period defined in Subsection (b) (2). If any such part fails during the period of warranty coverage, it must be repaired or replaced by the manufacturer according to Subsection (4) below. Any such part repaired or replaced under the warranty must be warranted for the remaining warranty period.

- (2) Any warranted part that is scheduled only for regular inspection in the written instructions required by subsection (d) must be warranted for the warranty period defined in Subsection (b) (2). A statement in such written instructions to the effect of "repair or replace as necessary" will not reduce the period of warranty coverage. Any such part repaired or replaced under warranty must be warranted for the remaining warranty period.
 - (3) Any warranted part that is scheduled for replacement as required maintenance in the written instructions required by subsection (d) must be warranted for the period of time prior to the first scheduled replacement point for that part. If the part fails prior to the first scheduled replacement, the part must be repaired or replaced by the engine manufacturer according to Subsection (4) below. Any such part repaired or replaced under warranty must be warranted for the remainder of the period prior to the first scheduled replacement point for the part.
 - (4) Repair or replacement of any warranted part under the warranty must be performed at no charge to the owner at a warranty station.
 - (5) Notwithstanding the provisions of Subsection (4) above, warranty services or repairs must be provided at all manufacturer distribution centers that are franchised to service the subject engines.
 - (6) The owner must not be charged for diagnostic labor that leads to the determination that a warranted part is in fact defective, provided that such diagnostic work is performed at a warranty station.
 - (7) The manufacturer is liable for damages to other engine components proximately caused by a failure under warranty of any warranted part.
 - (8) Throughout the emissions warranty period defined in Subsection (b) (2), the manufacturer must maintain a supply of warranted parts sufficient to meet the expected demand for such parts.
 - (9) Any replacement part may be used in the performance of any warranty maintenance or repairs and must be provided without charge to the owner. Such use will not reduce the warranty obligations of the manufacturer.
 - (10) Add-on or modified parts that are not exempted by the Air Resources Board may not be used. The use of any non-exempted add-on or modified parts will be grounds for disallowing a warranty claim. The manufacturer will not be liable to warrant failures of warranted parts caused by the use of a non-exempted add-on or modified part.
 - (11) The manufacturer issuing the warranty shall provide any documents that describe that manufacturer's warranty procedures or policies within five working days of request by the Air Resources Board.
- (d) Emission Warranty Parts List.
- (1) Fuel Metering System
 - (i) Carburetor and internal parts
 - (ii) Fuel Filter
 - (iii) Fuel Tank.
 - (2) Air Induction System
 - (i) Air cleaner plate (including choke system)
 - (ii) Air cleaner cover
 - (iii) Air cleaner element
 - (3) Ignition System
 - (i) Spark Plugs.
 - (ii) Magneto or electronic ignition system.
 - (iii) Spark advance/retard system.
 - (4) Miscellaneous Items Used in Above Systems
 - (i) Hoses, Sealing gaskets, belts, connectors, and assemblies.

Dolmar will furnish with each new engine written instructions for the maintenance and use of the engine by the owner.

(e) MAINTENANCE STATEMENTS

It is your responsibility to have all scheduled inspection and maintenance services performed at the times recommended in the 2007 and later Owner's Manual and to retain proof that inspection and maintenance services are performed at the times when recommended. **Dolmar** will not deny a warranty claim solely because you have no record of maintenance; however, Dolmar may deny a warranty claim if your failure to perform required maintenance resulted in the failure of warranted part. The proof, which you maintain, should be given to each subsequent owner of the engine. You are responsible for performing the scheduled maintenance described below based on the procedures specified in the 2007 and later Owner's Manual. The scheduled maintenance below is based on the normal engine-operating schedule.

PROCEDURE	INTERVAL
1) Clean engine and check bolts and nuts. Retighten if necessary.	: Every 8 hours (daily)
2) Check and refill engine oil (4 stroke engine only)	: Every 8 hours (refill daily up to upper limit)
3) Change engine oil (4 stroke engine only)	: Initial 20 hours and every 50 hours afterward
4) Check clogging of cooling air passage and cylinder fins. Remove and clean if necessary.	: Every 8 hours (daily)
5) Clean air cleaner.	: Every 8 hours (daily)
6) Check spark plug. Clean and adjust if necessary.	: Every 8 hours (daily)
7) Check muffler exhaust outlet (or port). Clean if necessary.	: Every 50 hours (monthly)
8) Check fuel filter. If clogged, replace with new one.	: Every 50 hours (monthly)
9) Adjust valve clearance, if applicable (4 stroke engine only).	: Every 200 hours (yearly)
10) Replace fuel lines.	: Every 200 hours (yearly)
11) Clean and inspect the complete engine. Replace any damaged or worn out parts.	: Every 200 hours
12) Replace packings and gaskets with new ones.	: Every reassembling

FEDERAL EMISSION COMPONENT DEFECT WARRANTY

EMISSION COMPONENT DEFECT WARRANTY COVERAGE - This emission warranty is applicable in all States, except the State of California

DOLMAR GmbH North American Division, (herein “**Dolmar**”) warrant to the initial retail purchaser and each subsequent owner, that this utility equipment engine (herein “engine”) was designed, built, and equipped to conform at the time of initial sale to all applicable regulations of the U.S. Environmental Protection Agency (EPA), and that the engine is free of defects in materials and workmanship which would cause this engine to fall to conform with EPA regulations during its warranty period.

For the components listed under PARTS COVERED, the dealer or service center authorized by **Dolmar** will, at no cost to you, make the necessary diagnosis, repair, or replacement necessary to ensure that the engine complies with applicable U.S. EPA regulations.

EMISSION COMPONENT DEFECT WARRANTY PERIOD

The warranty period for this engine begins on the date of sale to the initial purchaser and continues for a period of 2 years.

PARTS COVERED

Listed below are the parts covered by the Emission Component Defect Warranty. Some of the parts listed below may require scheduled maintenance and are warranted up to the first scheduled replacement point for that part.

- | | |
|---------------------------------------|--|
| 1) Fuel Metering System | 3) Ignition System |
| (i) Carburetor and internal parts | (i) Spark plug |
| (ii) Fuel filter, if applicable | (ii) Flywheel Magneto |
| (iii) Throttle stopper, if applicable | (iii) Ignition Coil |
| (iv) Choke System, if applicable | |
| 2) Air Induction System | 4) Miscellaneous Items Used in Above Systems |
| (i) Air cleaner plate | (i) Fuel hoses, clamps and sealing gaskets |
| (ii) Air cleaner case | |
| (iii) Air cleaner element | |

OBTAINING WARRANTY SERVICE

To obtain warranty service, take your engine to the nearest **Service Center authorized by Dolmar**. Bring your sales receipts indicating date of purchase for this engine. The dealer or service center authorized by **Dolmar** will perform the necessary repairs or adjustments within a reasonable amount of time and furnish you with a copy of the repair order. All parts and accessories replaced under this warranty become the property of **Dolmar**.

WHAT IS NOT COVERED

- * Conditions resulting from tampering, misuse, improper adjustment (unless they were made by the dealer or service center authorized by **Dolmar** during a warranty repair), alteration, accident, failure to use the recommended fuel and oil, or not performing required maintenance services.
- * The replacement parts used for required maintenance services.
- * Consequential damages such as loss of time, inconvenience, loss of use of the engine of equipment, etc.
- * Diagnosis and inspection charges that do not result in warranty-eligible service being performed.
- * Any non-authorized replacement part, or malfunction of authorized parts due to use of non-authorized parts.

OWNER'S WARRANTY RESPONSIBILITIES

As the engine owner, you are responsible for the performance of the required maintenance listed in your owner's manual, **Dolmar** recommends that you retain all receipts covering maintenance on your engine, but **Dolmar** can not deny warranty solely for the lack of receipts or for your failure to ensure the performance of all scheduled maintenance.

As the engine owner, you should however be aware that the **Dolmar** may deny your warranty coverage if your engine or a part has failed due to abuse, neglect, improper maintenance or unapproved modifications.

You are responsible for presenting your engine to the nearest dealer or service center authorized by **Dolmar** when a problem exists.

If you have any questions regarding your warranty rights and responsibilities, you should contact the **Dolmar Warranty Service Department at 1-888-OPE-PART for the information.**

THINGS YOU SHOULD KNOW ABOUT THE EMISSION CONTROL SYSTEM WARRANTY

MAINTENANCE AND REPAIRS

You are responsible for the proper use and maintenance of the engine. You should keep all receipts and maintenance records covering the performance of regular maintenance in the event questions arise. These receipts and maintenance records should be transferred to each subsequent owner of the engine. Dolmar reserves the rights to deny warranty coverage if the engine has not been properly maintained. Warranty claims will not be denied, however, solely because of the lack of required maintenance or failure to keep maintenance records.

MAINTENANCE, REPLACEMENT OR REPAIR OF EMISSION CONTROL DEVICES AND SYSTEMS MAY BE PERFORMED BY ANY REPAIR ESTABLISHMENT OR INDIVIDUAL; HOWEVER, WARRANTY REPAIRS MUST BE PERFORMED BY A DEALER OR SERVICE CENTER AUTHORIZED BY Dolmar. THE USE OF PARTS THAT ARE NOT EQUIVALENT IN PERFORMANCE AND DURABILITY TO AUTHORIZED PARTS MAY IMPAIR THE EFFECTIVENESS OF THE EMISSION CONTROL SYSTEM AND MAY HAVE A BEARING ON THE OUTCOME OF A WARRANTY CLAIM.

If other than the parts authorized by Dolmar are used for maintenance replacements or for the repair of components affecting emission control, you should assure yourself that such parts are warranted by their manufacturer to be equivalent to the parts authorized by Dolmar in their performance and durability.

HOW TO MAKE A CLAIM

All repairs qualifying under this limited warranty must be performed by **a service dealer authorized by Dolmar**. In the event that any emission-related part is found to be defective during the warranty period, you shall notify **Dolmar Warranty Service Department at 1-888-OPE-PART**. **Dolmar and you will be advised of the appropriate warranty service dealer or service providers where the warranty repair can be performed.**

MEMO

MEMO

MEMO



DOLMAR POWER PRODUCTS
PO Box 5007
Alpharetta
GA 30005-5007